

TOMTAR®

TOMTAR VFG

quad cane

User manual version: 1.0.1 EN

EN



Record of product identification data

We recommend making a note of your product identification data below so that you have these to hand if you have any queries about your product. All the data can be found on the product label (see "Product labelling").

TYP Type / model:	
REF Item No. / REF:	
UDI Serial number (21):	
 Date of manufacture:	
Other information/notes:	

Thank you for purchasing the TOMTAR VFG quad cane from DIETZ.

This product is a medical aid. In order to use it properly and avoid possible risks due to improper use, you must familiarise yourself thoroughly with its operation.

Read this user manual carefully before you begin using your product. It contains important notes and information that will enable you to enjoy the full technical benefits. In addition, it will provide you with information to help keep your product in safe working order while ensuring it retains its value for as long as possible.

If you have any questions or require additional

information, please contact the specialist retailer which supplied the product to you.

You will always find the latest information about your product on our website. For information or queries concerning product safety and on recalls, please contact DIETZ in writing or by telephone. You will find our contact information on the back of this user manual.



NOTE

A large-print version of the user manual is available for visually impaired persons at **www.dietz-group.de** in PDF format.

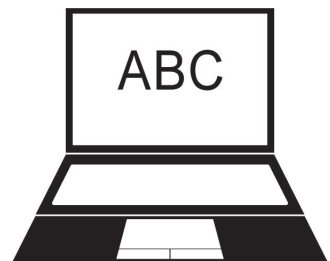

1 Important information		4 Technical specifications	
1.1	General information	5.1	Dimensions and technical information. . . 15
1.2	Intended purpose	5.2	Materials
1.3	Indications	5.3	Product tests
1.4	Contraindications	5.4	Ambient conditions
1.5	Symbols	5.5	Product labelling
2 Product description		6 Safety instructions	
2.1	Scope of delivery	6.1	Safety instructions
2.2	Reference diagram	7 Care and maintenance	
3 Preparing the quad cane for use		7.1	Servicing/maintenance
3.1	Assembling the quad cane	7.2	Maintenance schedule
3.2	Adjusting the height of the push handle 11	7.3	Troubleshooting
3.3	Right or left-handed use	7.4	Cleaning
3.4	Checking for correct assembly	7.5	Disinfection
4 Using the quad cane		7.6	Passing on the product for reuse.
4.1	Walking with the quad cane	7.7	Storage
4.2	Accessories and add-ons from third-party suppliers	7.8	Disposal
		8 Manufacturer's declarations	
		8.1	Warranty
		8.2	Service life
		8.3	Liability

1.1 GENERAL INFORMATION

This user manual is included in the scope of delivery and forms an integral part of the product. The user should keep this manual to hand at all times and it must remain with the product if passed on to a third party. We reserve the right to make changes to the versions shown in this user manual as a result of further technical development. Reprints, translations and

reproductions of this manual in any form, whether in whole or in part, require the written approval of DIETZ GmbH.

The copyright is owned by the manufacturer. The latest version of the user manual can be accessed at any time by going to **www.di-etz-group.de**. Please read the user manual before assembling and using the product.

1.2 INTENDED PURPOSE

The TOMTAR VFG quad cane is intended for use by persons with restricted mobility weighing up to 100 kg. Its purpose is to provide additional support and stability while standing or walking and to relieve some of the strain on the body. It is designed for single-handed use (on the left or right) and partially relieves the strain on the user's body while helping them with coordination.

It is height adjustable, lightweight and suitable for use in enclosed spaces as well as outdoors.

The walking aid is not suitable for children or for anyone who is less than 130 cm tall.

The quad cane can be used both in the home and in hospitals, and is designed exclusively for use on firm and level walking surfaces.

1.3 INDICATIONS

Use of the TOMTAR VFG quad cane is indicated for:

- ▼ Impaired mobility due to a restriction of the active or passive musculoskeletal system
- ▼ Coordination problems when walking
- ▼ Reduced load-bearing capacity

1.4 CONTRAINDICATIONS

Use of the TOMTAR VFG quad cane is unsuitable in the case of:

- ▼ Perception disorders
- ▼ Severe balance disorders
- ▼ Inability to stand unaided
- ▼ A user weight exceeding 100 kg

1.5 SYMBOLS

These symbols indicate passages of text that are helpful for using and operating the product in everyday life.



WARNING

It is mandatory to observe and comply with warnings. They draw your attention to the fact that failure to comply may result in injury and/or damage to the product or the environment. _____



NOTE

Tips and advice which make using the various functions easier. _____

2.1 SCOPE OF DELIVERY

Once you have unpacked the TOMTAR VFG quad cane, check that it has been supplied with all of its parts and that it is not damaged. If the contents are noticeably damaged, inform the freight company immediately.

The following components are included in the scope of delivery of the TOMTAR VFG quad cane:

- ▼ TOMTAR VFG quad cane
- ▼ User manual



WARNING

Risk of poisoning: When burnt, packaging films can release toxic gases.

Risk of suffocation: Keep plastic bags out of the reach of children. _____

2.2 REFERENCE DIAGRAM



NOTE

The image above is designed to help you clearly identify the individual components of your quad cane. Therefore, please always refer to it when reading the user manual. _____

ASSEMBLY INSTRUCTIONS

The TOMTAR VFG quad cane is supplied in two parts (push handle & frame).

3.1 Assembling the quad cane

1. If necessary, loosen the thread of the bushing by turning it anticlockwise (1, Fig. 1). Do not unscrew the top part of the bushing completely. Simply loosen the connection.
2. Hold the black push handle at the bottom, where the two spring pins are located.
3. Press in both spring pins (2, Fig. 1). At the same time, insert the push handle into the frame at the top of the bushing (3, Fig. 1).
4. Keep inserting the push handle until the spring pins pop out through the holes.
5. The spring pins must make a clearly audible noise as they click into place. The spring pins should now be noticeably protruding from the holes (1, Fig. 2).
6. Tighten the thread of the bushing by turning it clockwise (2, Fig. 2).
7. Your quad cane is now fully assembled.

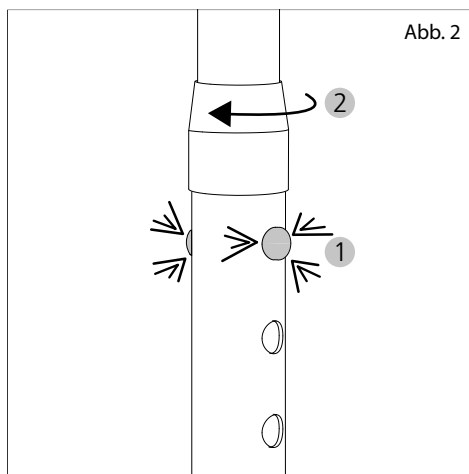
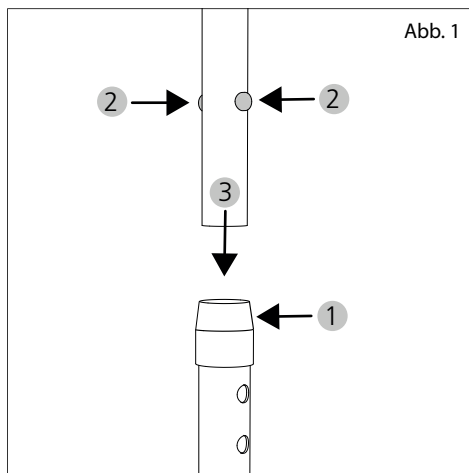

WARNING

Danger of crushing! Be careful of your fingers when tightening the bushing. _____

3.2 Adjusting the height of the push handle

You can adjust the height of the TOMTAR VFG quad cane to suit you.

1. Loosen the bushing (1, Fig. 3).
2. Press in both spring pins and twist the push handle round very slightly so that it is free to move (2, Fig. 3).
3. You can now set the quad cane to the required height by sliding the push handle up or down until the spring pins engage in the appropriate set of holes.
4. Make sure that you clearly hear the spring pins click into place after adjusting the height (1, Fig. 2). The spring pins should now be noticeably protruding from the holes.
5. Retighten the thread of the bushing (2, Fig. 2).



WARNING

Safety hazard! Once the height has been adjusted, both spring pins must click securely into place. Otherwise, the parts of the product could come apart and the user could fall. _____



Abb. 3



NOTE

To enable correct use of the quad cane, it must be adjusted to your individual height. Ideally, the height should be set to the distance between the floor and your wrist. This will allow you to walk upright with your elbow slightly bent.

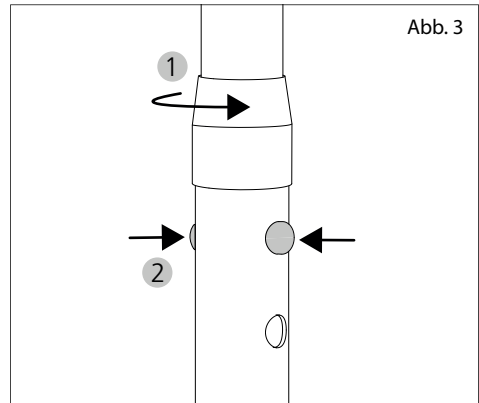
Your specialist retailer will adjust the height for you.

If you subsequently realise that the result of the height adjustment process is not quite right, you can adjust the height yourself by following the description in this section of the document. _____

3.3 Right or left-handed use

Once the height of the TOMTAR VFG quad cane has been adjusted, check that it is appropriate for using the product on the preferred side of your body (left or right).

1. Hold the quad cane with your preferred hand.
2. The two furthest extending feet must point away from your body (Fig. 4) and the open end of the hand grip must point backwards (see reference diagram on page 9).
3. If this is not the case, loosen the bushing.
4. Press in both spring pins and twist the push handle 180° without changing the height (Fig. 5).
5. Make sure that the spring pins re-engage in the holes.
6. Retighten the bushing.
7. If you now hold the walking aid with your preferred hand, the hand grip will be pointing in the other direction and the furthest extending feet will be pointing away from your body.

3.4 Checking for correct assembly

Now check that the TOMTAR VFG quad cane has been correctly assembled:

- ▼ The quad cane must stand securely upright on all four rubber pads.
- ▼ The spring pins must be properly engaged. For this to be the case, they must protrude slightly on the outside.
- ▼ The bushing must be screwed tight.
- ▼ All parts of the quad cane must be securely assembled.



WARNING

Danger of falling! The quad cane must be adjusted for use on the correct side (left or right). Otherwise, there is a danger of tripping and falling!



Abb. 4



Abb. 5

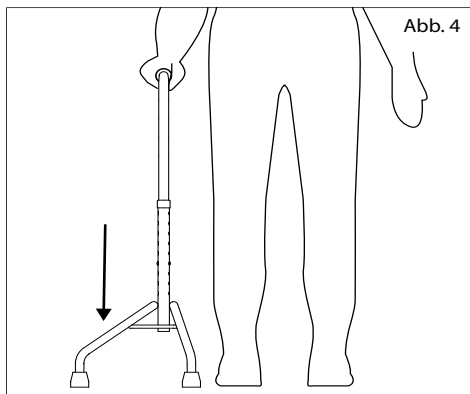

NOTE

If you are unsure as to whether the quad cane is assembled correctly, please contact your medical supply store or an authorised specialist retailer.

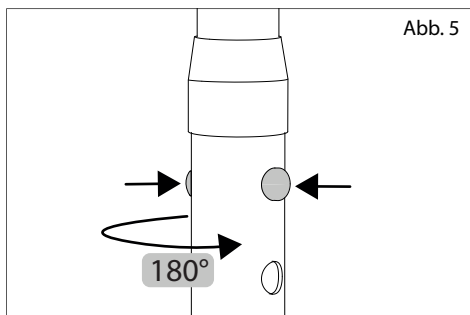
USING THE QUAD CANE

Familiarise yourself thoroughly with your TOMTAR VFG quad cane before using it for the first time so that you feel safe and confident to do so.



NOTE

Try out your new quad cane with somebody else present (e.g. your carer). _____

4.1 Walking with the quad cane

The TOMTAR VFG quad cane is a walking aid that you can rely on to boost your confidence and give you more stability while walking.

Please read the following notes carefully before using the quad cane for the first time:

1. Always hold the quad cane with the correct hand. You can tell whether you have got it right by checking that the two furthest extending feet are pointing away from your body (Fig. 4).
2. Always hold the quad cane firmly by wrapping your entire hand around the hand grip.
3. Ensure that you have a firm footing! When setting the quad cane down on the floor, make sure that you keep it vertical and sufficiently close to your body, ensuring that all four of its feet touch the floor.
4. Once you are sure that the quad cane is stable, you can start moving by taking short steps.
5. The quad cane has been designed for use in enclosed spaces and outdoors. The walking surface must be firm and level. Only then can you be sure that all four feet of the walking aid are making firm contact with the floor or ground.
6. Avoid any kind of walking surface that is heavily soiled or has loose materials scattered over the top, e.g. pebble stones or coarse dirt. On walking surfaces such as this, there is a risk of the quad cane slipping.



WARNING

Safety hazard! The product is only to be used on a firm, level walking surface that is free of heavy soiling, loose materials and significant bumps.

Danger of falling! While walking, do not set the quad cane down too far in front of you/to the side of you. _____

4.2 Accessories and add-ons from third-party suppliers

In general, only original accessories from DIETZ GmbH may be used.

The TOMTAR VFG quad cane is not designed to have any accessories attached.

If third-party products are installed on the quad cane, responsibility for the safety of the product passes to the person who installs the accessories or add-ons. In this case, the installer or fitter must issue a new declaration of conformity for the combination of accessories and product or add-on and product. The conformity declared by DIETZ according to MDR 2017/745, Annex II is rendered null and void.



WARNING

Product safety! The safety of the product cannot be guaranteed if add-ons/accessories are sourced from anyone other than DIETZ or modifications are made by anyone other than DIETZ. _____



WARNING

Product safety! If accessories or add-ons are fitted to the product, then the safety instructions in the user manual for the accessories or add-ons must always be observed. _____

5.1 DIMENSIONS AND TECHNICAL INFORMATION

Description	Unit	Value(s)
Item number		200380
Height (min. – max.)	mm	720 – 920
Base, length / width / height	mm	340 / 290 / 210
Ground clearance	mm	140
Weight	kg	0.9
Maximum user weight	kg	100
Recommended body height	m	1.30 – 1.80
Inner static stability (in direction of least extending feet)	°	3.4 (according to EN ISO 11334-4)
Outer static stability (in direction of furthest extending feet)	°	10.3 (according to EN ISO 11334-4)
Static stability, forwards	°	7.6 (according to EN ISO 11334-4)
Static stability, backwards	°	8.3 (according to EN ISO 11334-4)
Adjustability of push handles		9 increments of 25 mm

5.2 MATERIALS

Material / colour	Details
Frame	Aluminium / powder coated / manganese grey metallic
Push handle	Aluminium / anodised / black
Bushing	Plastic, PE / orange
Hand grip	Foam, EVA / black
Rubber pads	Rubber, PVC / black

5.3 PRODUCT TESTS

Standard for walking sticks with three or more legs	EN ISO 11334-4
Biocompatibility	ISO 10993

5.4 AMBIENT CONDITIONS

Ambient temperature during operation	-10°C to +50°C
Ambient storage conditions	0°C to 45°C 20% to 75% relative humidity

5.5 PRODUCT LABELLING

The product label must always remain legible. In the case of the TOMTAR VFG quad cane, it is located on the bottom of one of the extending feet. See "Reference diagram".

If the product label is illegible, have it replaced by your specialist retailer immediately.

The next page contains a table with a detailed explanation of all the symbols and information on the product label (Fig. 6). The product label also contains the serial number of your walking aid.

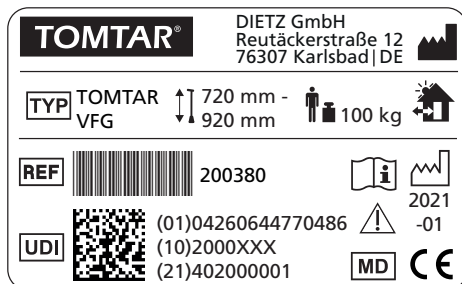















Fig. 6

	Trademark or brand
	TYPE / model
	REF = Item number
	UDI = Unique device identifier (01) UDI-DI (10) Order number (21) Serial number
	Manufacturer / manufacturer's logo / contact address
	Maximum user weight
	Date of manufacture
	Adjustable height (min. – max. height)
	Quad cane can be used both indoors and outdoors
	Follow the user manual
	Caution! – Always follow the safety instructions in the user manual
	Medical Device
	The product conforms to Regulation (EU) 2017/745 on medical devices

6.1 SAFETY INSTRUCTIONS

When using the TOMTAR VFG quad cane, always observe the following safety instructions to prevent falls, hazardous situations and damage to the product:

- ▼ The quad cane may only be used on a firm, level walking surface.
- ▼ Avoid walking surfaces with holes; otherwise, the walking aid may topple unexpectedly. Always pay attention to where you are setting down your quad cane.
- ▼ Take particular care on flooring that is not anchored, such as rugs, which may slide around.
- ▼ Avoid steep paths.
- ▼ The quad cane must stand securely upright on all four feet.
- ▼ Check that all parts of the quad cane are securely assembled prior to each use.
- ▼ Check that the spring pins are properly engaged prior to each use. Otherwise, the quad cane could accidentally collapse as soon as you put your weight on it, thereby creating a danger of falling.
- ▼ Avoid uneven and wet floors, as well as icy surfaces. Make sure that the walking surface you are using provides enough grip for your walking aid.
- ▼ Do not use your quad cane on a loose walking surface such as gravel, sand or foliage, as this will restrict its ability to achieve a firm footing.
- ▼ Attention: Please note that shifts in balance caused by body movements may increase the risk of the quad cane tipping over. Ensure that the load on the quad cane is never too great.
- ▼ Use the quad cane with one hand only.
- ▼ Do not hang any bags from the hand grip of the quad cane. There is a risk of it tipping over!
- ▼ Be careful of your fingers during assembly and when adjusting the height of the telescopic rod. There is a risk of getting them trapped!
- ▼ Never exceed the maximum user weight of 100 kg! This is stated on the product label of your quad cane.
- ▼ Do not expose the quad cane to prolonged periods of direct sunlight or low temperatures, as this could cause parts of the product (e.g. frame or grips) to become very hot (> 41°C) or cold (<0°C), potentially causing injuries to the skin.
- ▼ Never use the quad cane while under the influence of alcohol or other substances that can negatively affect your attentiveness and ability to react!
- ▼ Only use the quad cane for its intended purpose. It must not be used as a standing aid to help you get up, as a lever for objects or as a tool for operating switches (e.g. light switches).

- ▼ The quad cane is not a toy and must be kept away from children.
- ▼ Observe the road traffic regulations when out and about on public streets.
- ▼ Take particular care when the lighting conditions are poor, as dips and bumps in the walking surface will be more difficult to see.
- ▼ Never take the quad cane onto an escalator due to the increased danger of falling!
- ▼ Do not use the quad cane as a support when climbing steps or stairs. In the interest of safety, always hold on to the banister/hand rail. Alternatively, only use steps/stairs when you have somebody there to help you (e.g. a carer), or use a lift or a ramp.
- ▼ Clean the quad cane thoroughly whenever it has come into contact with sand, seawater or road salt.
- ▼ The quad cane must not be used in water, as this can damage it.
- ▼ Make sure you dry the quad cane if it gets wet.
- ▼ The quad cane must not be modified in terms of its structure or design. Otherwise, DIETZ GmbH will no longer be able to guarantee the safety of the product on grounds of liability.
- ▼ For the same reason, only original spare parts and original accessories are to be used.
- ▼ Serious incidents that occur in relation to the quad cane must be reported to the manufacturer and the responsible authorities!
- ▼ If you notice any functional problems with your quad cane, please take it to your authorised specialist retailer for repair immediately.
- ▼ Following storage periods of more than a year, the product must not be used again until all the inspections stipulated in the maintenance schedule have been performed.

7.1 SERVICING/MAINTENANCE

We recommend performing the inspections listed in the maintenance schedule at regular intervals to ensure that the TOMTAR VFG quad cane is always safe to use.

Improper or insufficient product care and maintenance will result in restricted liability on the part of the manufacturer.

The maintenance schedule does not provide any information on the amount of work that will actually need to be performed on the product.



NOTE

As the user, you will be the first to notice any damage. If you notice a fault as described in the maintenance schedule or further defects and functional impairments, contact an authorised specialist retailer immediately. _____



WARNING

To maintain the operational safety of the product, repairs must only be performed by specialist shops using DIETZ original spare parts. The relevant spare parts catalogue can be found on our website under the information for the product concerned. _____



NOTE

Unless otherwise stated, the inspections and measures stipulated in the maintenance schedule must be performed by the user or their care assistant. _____



NOTE FOR SPECIALIST RETAILERS:

If the user reports product abnormalities, please check all the inspection points listed in the maintenance schedule. The checks must also be performed after longer storage periods (> 4 months) and whenever the product is going to be re-used. _____

7.2 QUAD CANE MAINTENANCE SCHEDULE

What to check	Description	Monthly	
		Before use	
Hand grip: Stability	The hand grip must not be damaged or wobbly.	x	
Spring pins: Function	1. The spring pins must push in when you apply pressure so that the telescopic rod can be adjusted. 2. The spring pins must make a clearly audible noise as they click back into place.	x	
Push handle: Function & safety	1. The height of the push handle must be easy to adjust when the spring pins are pushed in. 2. The push handle must not be bent or show any other signs of damage.	x	
Frame & rubber pads: Stability	1. The frame must not be bent or show any other signs of damage. 2. The holes of the frame must not be badly worn. If the holes are worn out, the spring pins are not guaranteed to lock securely in place! 2. All four rubber pads must be resting on the walking surface. 3. All four rubber pads must be securely connected to the frame and must not show any signs of excessive wear. 4. The orange bushing at the top end of the frame must be securely connected to the frame. 5. The top part (inner thread) of the bushing must be present and be easy to screw on and off.	x	
Entire walking aid: Function & damage	1. The push handle and frame must not be damaged or cracked. 2. The push handle and frame must not be bent. If they are bent, you must not attempt to straighten them. 2. Functional damage or surface damage must be rectified.		x
Visual inspection: Loose parts, fractures, corrosion or other damage	 If this type of damage is detected, the walking aid must no longer be used, as safe use is no longer guaranteed!		x
Dirt: Entire walking aid:	The entire walking aid must be cleaned based on how dirty it is, but at least once a month (see "Cleaning").		x
Product label: Legibility	The product label must be properly legible.		x

7.3 TROUBLESHOOTING

What	Possible causes	Measures
The height of the push handle changes without you wanting it to.	The spring pins are not correctly engaged.	Lock the spring pins at the correct height, making sure that they audibly click into place and noticeably protrude from the holes.
	The spring pins are defective.	Consult an authorised specialist retailer.
The quad cane is not resting on the floor/ground with all four feet.	The walking surface is not level.	Only use the quad cane on a firm, level walking surface that is free of course dirt.
	A stone or some other small object has got stuck in the rubber pads.	Remove all dirt and foreign materials from the rubber pads.
	The frame is bent. The rubber pads are not securely connected to the frame or are damaged.	Consult an authorised specialist retailer.
The push handle wobbles even though the spring pins are engaged.	The push handle is warped.	Consult an authorised specialist retailer.
	One of the spring pins is defective, with the result that the push handle is not fully locked.	
The hand grip of the quad cane does not provide a proper grip.	The hand grip is damaged or loose.	Consult an authorised specialist retailer.

7.4 CLEANING

- ▼ To clean the product, regularly clean the push handle and bottom part of the quad cane by wiping them with a damp cloth.
- ▼ If the product is very dirty, you can use a mild detergent and warm water.
- ▼ Remove all dirt, stones and similar forms of soiling from the rubber pads.
- ▼ Only ever use standard mild cleaning and disinfection products to clean the product.

Detailed information on disinfection can be found in the following section.

7.5 DISINFECTION

When manually reconditioning a used aid for reuse, all of the components must be thoroughly treated/wiped with a disinfectant. Take particular care to disinfect surfaces that come into frequent contact with hands/skin, such as the hand grip.

Please only use the following disinfectants (use of other chemicals might damage the product):

- ▼ Aldehyde-free, alcohol-based disinfectants (max. 70% propyl alcohol)



WARNING

Material damage: Do not use high-pressure cleaners, strong, corrosive chemicals or scouring agents for cleaning purposes.

After cleaning, ensure that all materials are fully dry in order to preserve their quality. _____



WARNING

Material damage: Observe the use and processing instructions issued by the cleaning agent/disinfectant manufacturer. _____

7.6 PASSING ON THE PRODUCT FOR REUSE

Your product is suitable for transfer to/reuse by others. The number of times it can be reused depends on the material wear conditions and the functional capabilities of the respective product.

When passing on the product for reuse, please remember to hand over all the technical documents necessary for safe handling and use to the new user or the specialist retailer.

Before it is reused, the product must be cleaned, disinfected, checked for damage and approved by a specialist retailer.

As part of this, all the inspection points listed in the maintenance schedule must be checked on the product.

7.7 STORAGE

If you wish to store the product, ensure that it is kept in a dry place protected against direct, strong sunlight and at a temperature of 0°C to +45°C.

Make sure that there is no risk of the quad cane falling over and its surfaces being damaged as a result.

After longer periods of storage (> 4 months), please check all the inspection points on the product as listed in the maintenance schedule before reusing/redeploying the product.



WARNING

Do not store the product near a heat source and do not place any objects on the product during storage.

7.8 DISPOSAL

If you no longer need the product, please contact your specialist retailer. They will then pick up the product and either dispose of it properly or make further use of it. Otherwise, please take the product to your local waste disposal facility.

8.1 WARRANTY

The warranty covers all product defects which are verifiably attributable to material or manufacturing flaws. The warranty period is 24 months as of receipt of notification of readiness for shipping, but following delivery at the latest. The warranty does not cover damage which has

occurred due to natural wear and tear, or has been caused deliberately or through negligent or improper operation or use. This also applies to the use of unsuitable care products, lubricating oils or greases.

8.2 SERVICE LIFE

The product has an expected service life of five years when used daily and exactly as intended. This assumes compliance with the maintenance

and safety instructions stipulated in this manual. The indicated service life does not constitute any kind of additional warranty.

8.3 LIABILITY

DIETZ GmbH only bears liability if the products are used under the specified conditions and for the specified purposes. It is very important to handle and care for the products properly as per the instructions.

DIETZ GmbH is not liable for damage caused by components and spare parts that have not been approved by DIETZ GmbH. Repairs must only be carried out by authorised specialist retailers or by the manufacturer itself.

TOMTAR®



Product group: Walking aids
Product: TOMTAR VFG quad cane

User manual version: 1.0.1 EN

Last update: 2022-07 (MFZ)

DIETZ GmbH

Reutäckerstrasse 12
76307 Karlsbad
Germany

Tel.: +49 7248.9186-0

Fax: +49 7248.9186-86

info@dietz-reha.de

www.dietz-group.de

TOMTAR is a registered trademark belonging to DIETZ GmbH.

TOMTAR products are sold by DIETZ GmbH.

Misprints and errors excepted. Prices and products subject to change without notice.
© DIETZ GmbH, Karlsbad
Not to be reproduced, whether in part or in whole, without the written permission of
DIETZ GmbH, Karlsbad.